

### Arrow

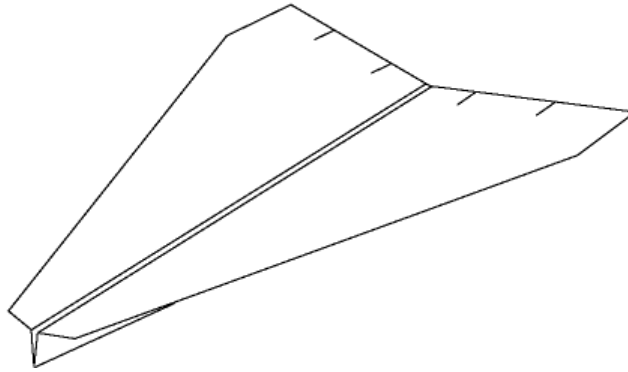

This plane is easy to fold and flies straight and smooth. Add a small amount of up elevator for long level flights.

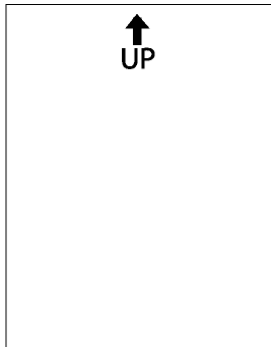

Orient the template with the “UP” arrow at the top of the page. Then, flip the paper over onto its backside, so that you cannot see any of the fold lines.

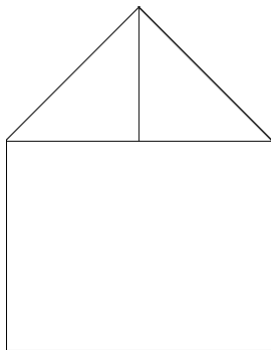

Pull the top right corner down toward you until fold line 1 is visible and crease along the dotted line. Repeat with the top left corner.

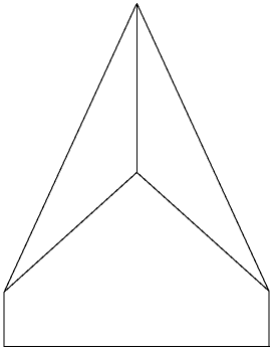

Fold the right side over again and crease along fold line 2.  
Repeat with the left side.

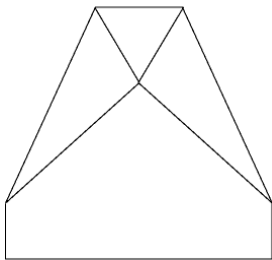

Fold the tip down toward you and crease along fold line 3.

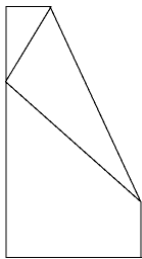

Now, flip the paper over. Then, fold the left side over onto the right side and crease along fold line 4 so that the outside edges of the wings line up.

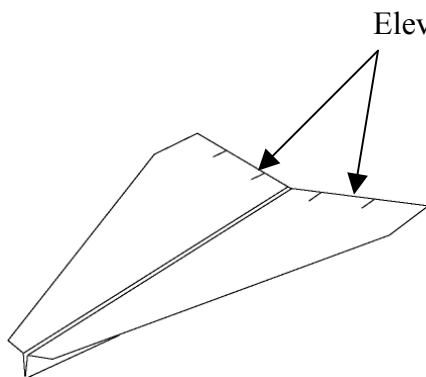

Fold the wings down along fold lines 5. Partially open the folds you just created so that the wings stick out straight. Cut two slits, one inch apart, along the back edge of each wing for elevator adjustments. Add wing dihedral by tilting the wings up slightly away from the fuselage. The wings will have a slight “V” shape when viewed from the front. Read the Introduction for more information about dihedral. Now you are ready to fly!

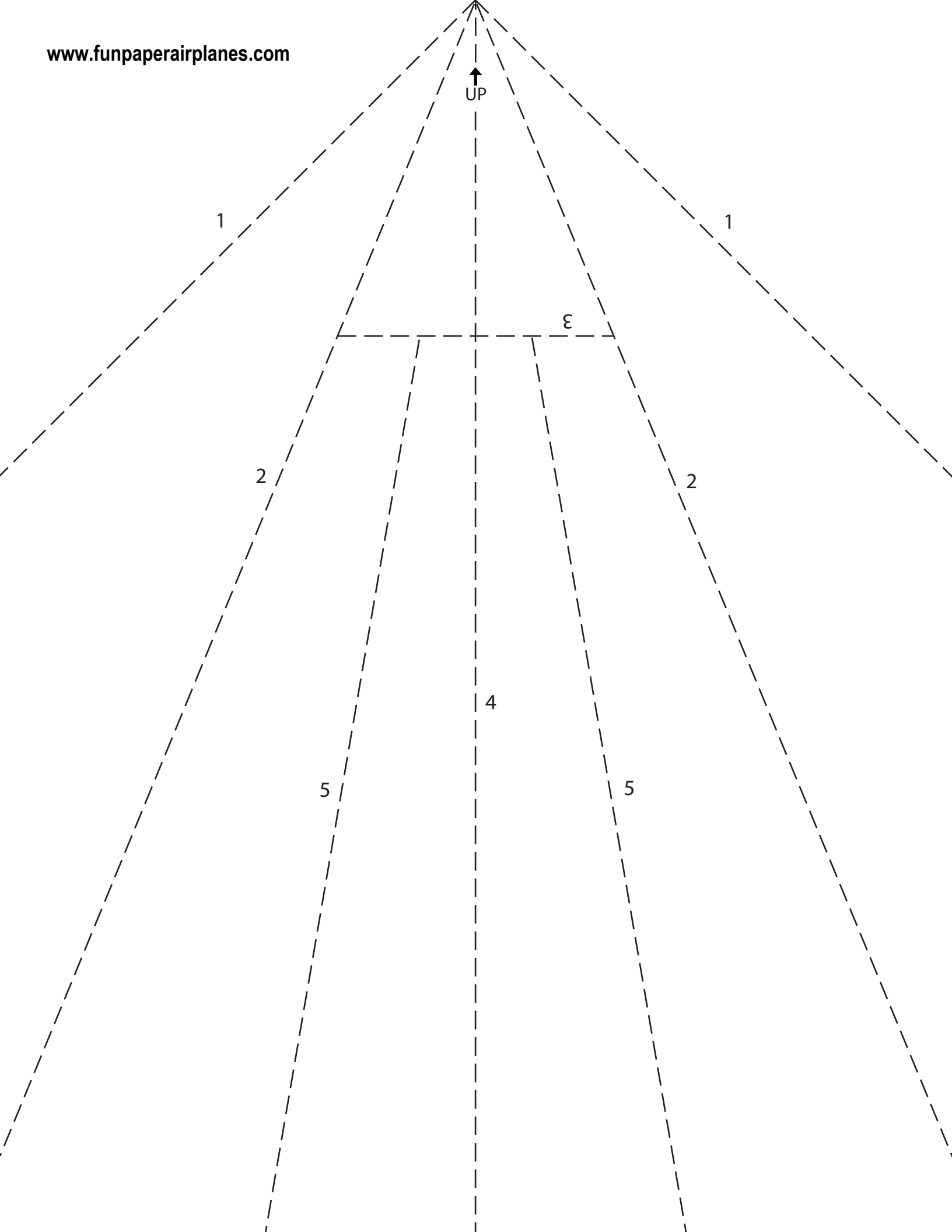

### Canard

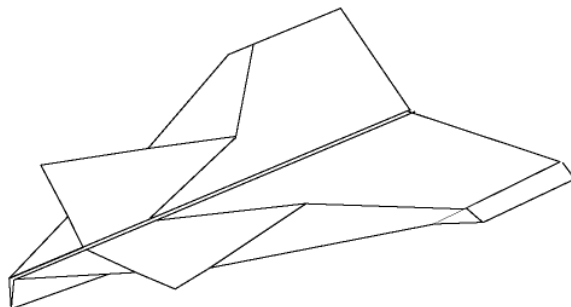

This unique plane has small wings at the front called “canards.” This design is surprisingly stable and will float long and straight if folded carefully.

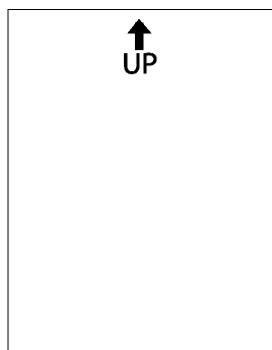

Orient the template so that the “UP” arrow is at the top of the page. Then flip the paper over so that none of the fold lines are showing.

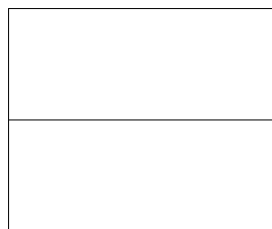

Fold the top edge of the paper down toward you until fold line 1 becomes visible. Make a crease along the dotted line.

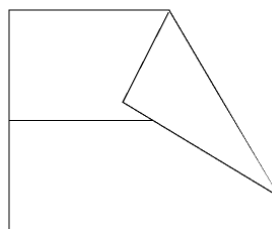

Fold the top right corner down and toward you and make a crease along fold line 2. Be aware that you will not be able to see the fold line after making this fold.

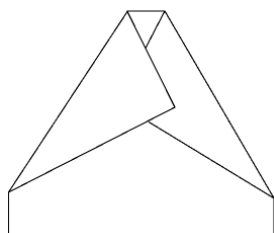

Fold the top left corner down and toward you and make a crease along fold line 3.

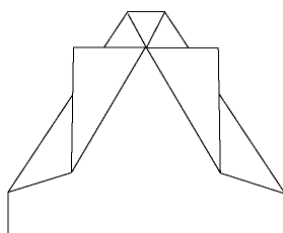

Fold the corners of the flaps you just folded up along fold lines 4.

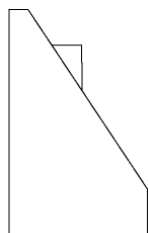

Fold the left half of the plane over onto the right half along fold line 5 so that the outside edges of the wings line up.

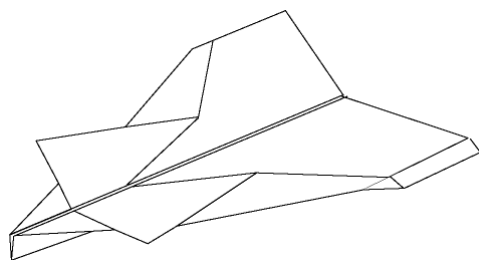

Fold the wings down along fold lines 6 and winglets down along fold lines 7. Add wing dihedral by tilting the wings up slightly away from the fuselage. The wings will have a slight “V” shape when viewed from the front. You are ready to fly!

UP

2

3

1

4

4

5

6

6

7

7

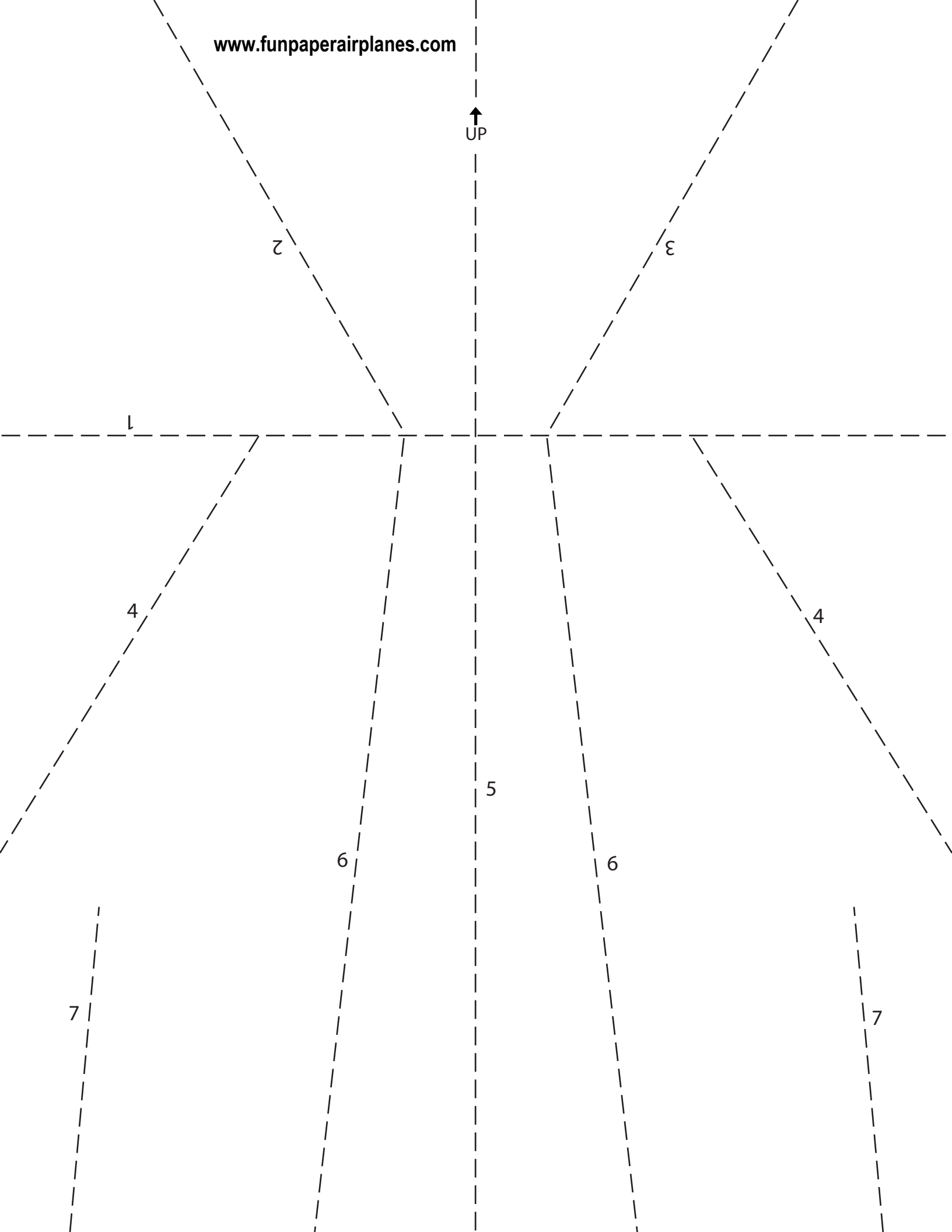

### Classic Dart

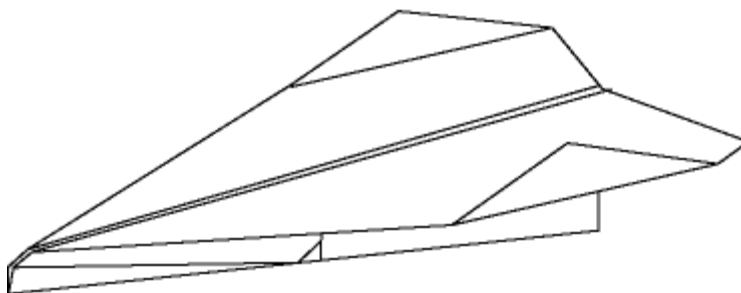

This plane is the classic schoolyard dart. It has short, compact wings and will fly straight as an arrow. It generally needs some up elevator along the back wing edges to fly properly.

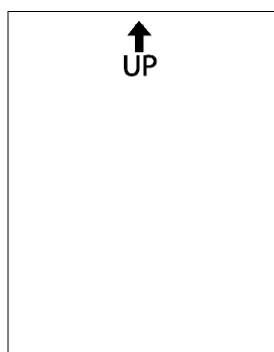

Orient the template with the “UP” arrow at the top of the page. Then, flip the paper over onto its backside, so that you cannot see any of the fold lines.

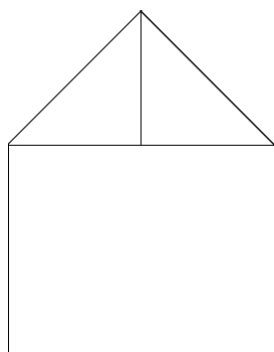

Pull the top right corner down toward you until fold line 1 is visible and crease along the dotted line. Repeat with the top left corner.

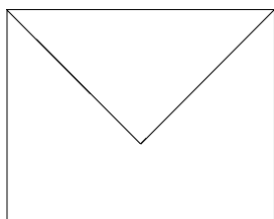

Fold the top point down toward you until fold line 2 is visible and crease along the dotted line.

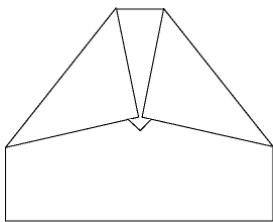

Fold the top left and top right corners down and toward you and crease along fold lines 3.

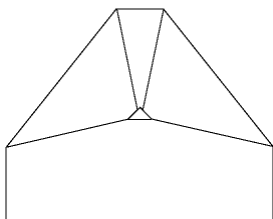

Fold the tip up and over the two diagonal folds along fold line 4 to secure them in place.

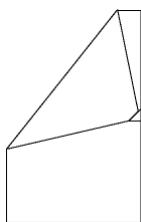

Flip the plane over and fold the right side over onto the left side as shown along fold line 5 so that the outside edges of the wings line up. Also make sure the diagonal folds do not become untucked from the tip you folded up in the previous step.

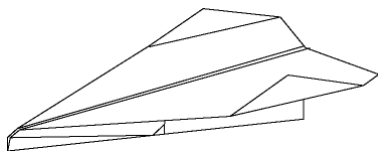

Fold the wings down along fold lines 6 and the winglets up along fold lines 7. Add wing dihedral by tilting the wings up slightly away from the fuselage. The wings will have a slight “V” shape when viewed from the front. Cut two slits, one inch apart, along the back edge of each wing to make elevator adjustments. Start out by trying some up-elevator. You are ready to fly!



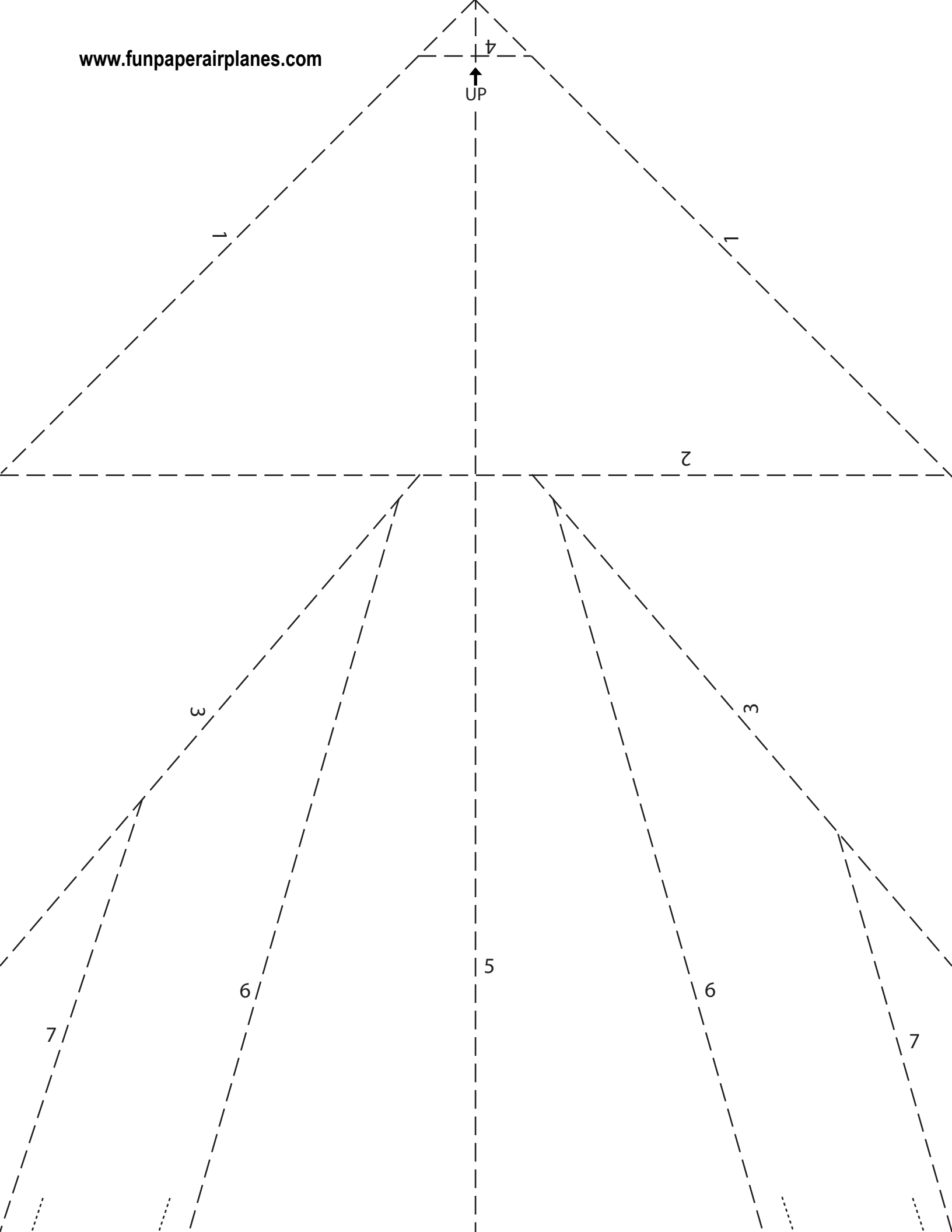

### Condor

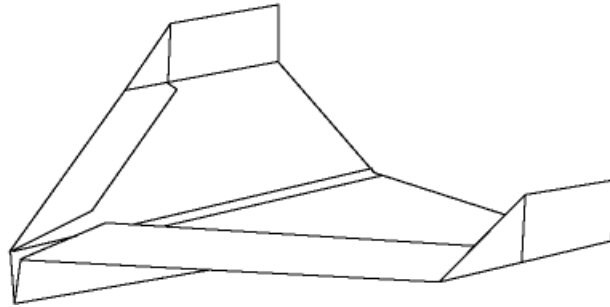

This plane produces tremendous lift at low speed, giving it a very low glide slope. It is an excellent indoor flier and will coast across the room on slow, smooth glides.

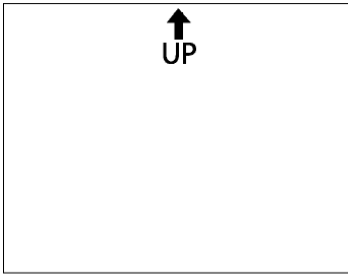

Orient the template so that the “UP” arrow is at the top of the page. Then flip the paper over so that none of the fold lines are showing.

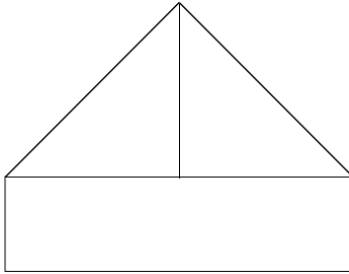

Fold the top left corner down toward you until fold line 1 becomes visible. Crease along the dotted line and repeat with the top right corner.

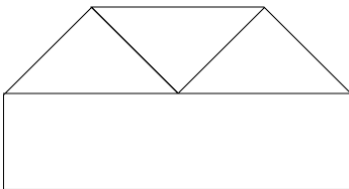

Fold the nose down until fold line 2 becomes visible and crease along the dotted line.

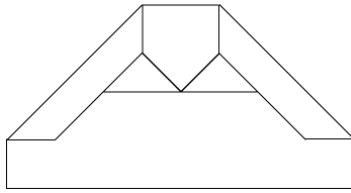

Fold the outside wing edges in and crease along fold lines 3.

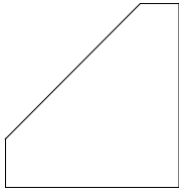

Fold the right half of the plane over the left half and crease along fold line 4 so that the outside edges of the wings line up.

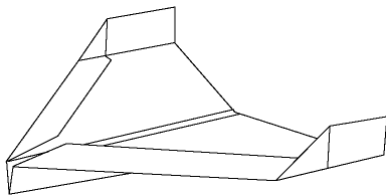

Fold the wings down along fold lines 5 and the winglets up along fold lines 6. Add wing dihedral by tilting the wings up slightly away from the fuselage. The wings will have a slight “V” shape when viewed from the front. Add elevator slits along the back edge of the wings to adjust the flight if necessary. You are ready to fly!

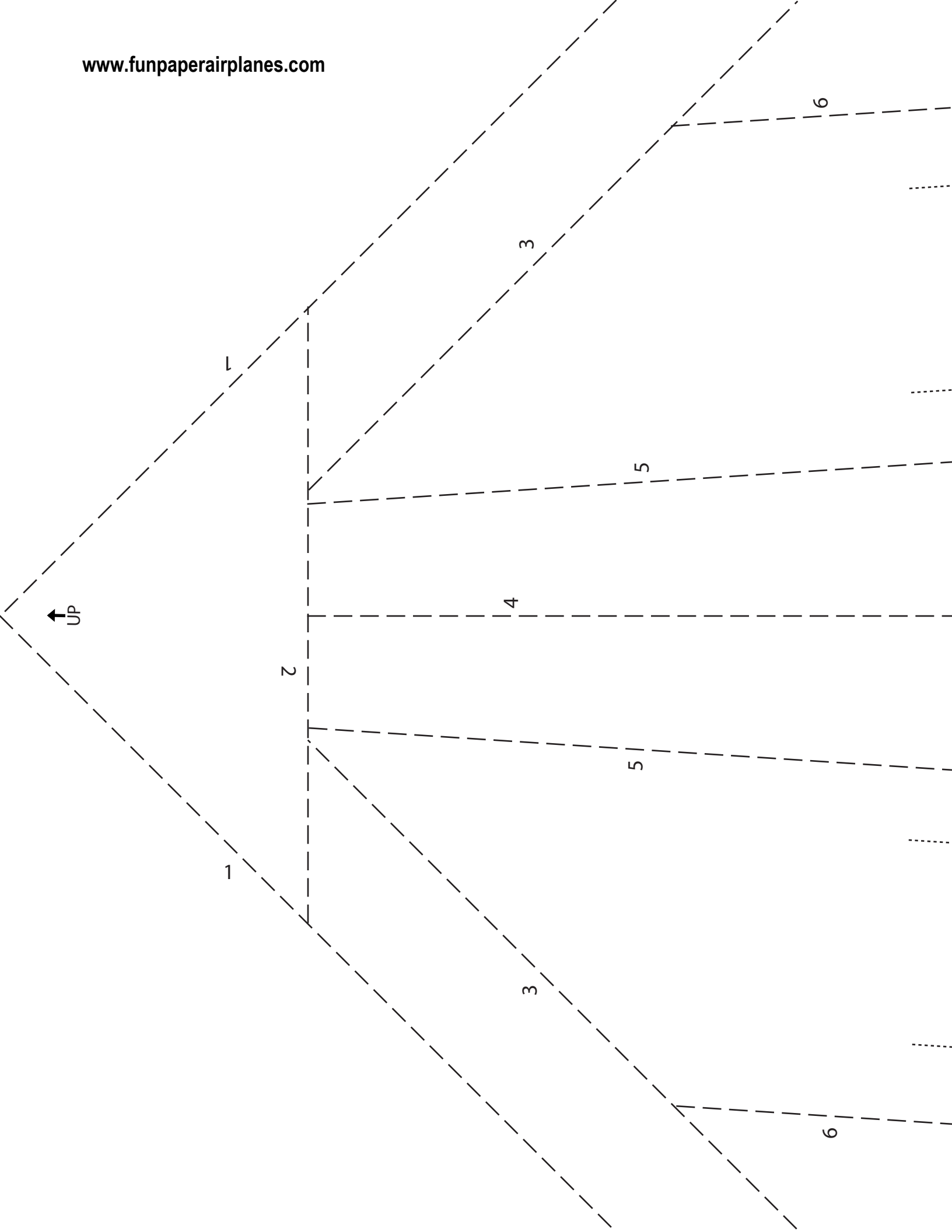

## Delta

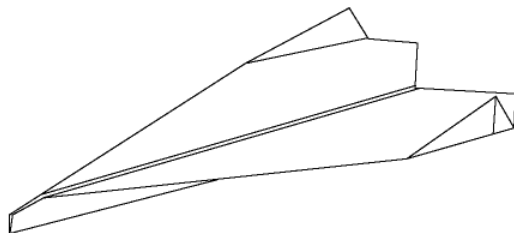

This plane flies fast and straight. It is easy to fold and a great all around flier. Add some up elevator if necessary to produce stable flights.

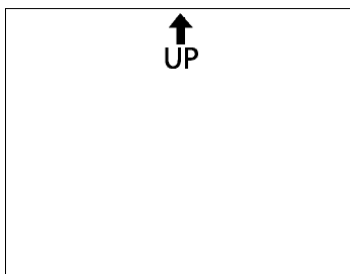

Orient the template so that the “UP” arrow is at the top of the page. Then flip the paper over so that none of the fold lines are showing.

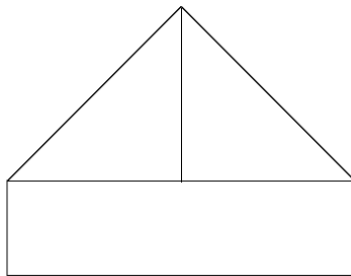

Fold the top left corner down toward you until fold line 1 becomes visible. Crease along the dotted line and repeat with the top right corner.

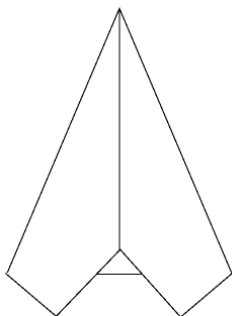

Fold the left side over again and crease along fold line 2. Repeat with the right side.

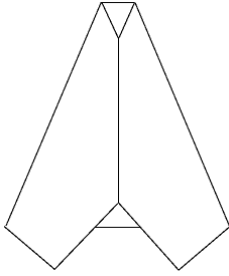

Fold the nose down and toward you along fold line 3.

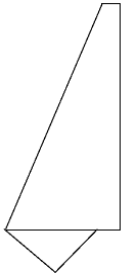

Fold the right half of the plane over the left half along fold line 4 so that the outside edges of the wings line up.

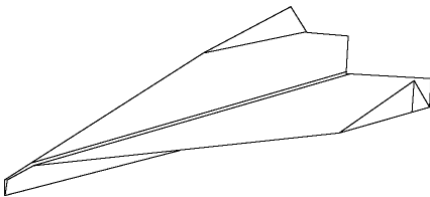

Fold the wings down along fold lines 5 and the winglets up along fold lines 6. Add wing dihedral by tilting the wings up slightly away from the fuselage. The wings will have a slight “V” shape when viewed from the front. You are ready to fly!

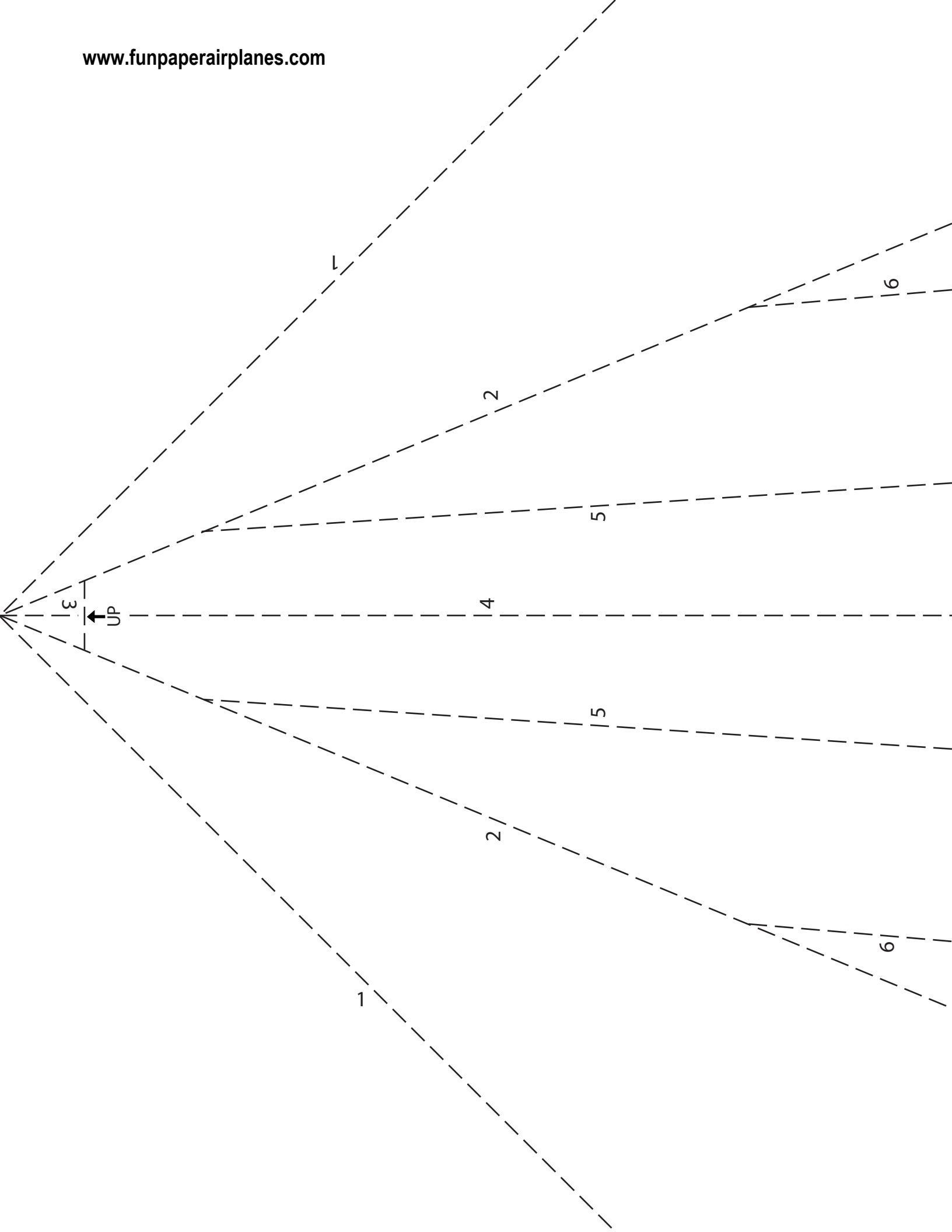

## Raptor

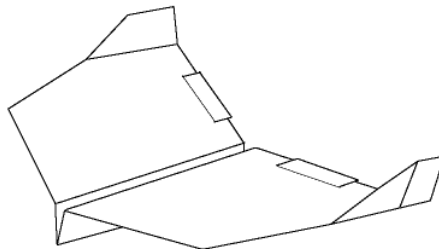

This plane is an excellent outdoor glider. Launch straight up and it will glide down in big lazy circles. Adjust the elevator on the back edge of the wing to perfect the flight characteristics.

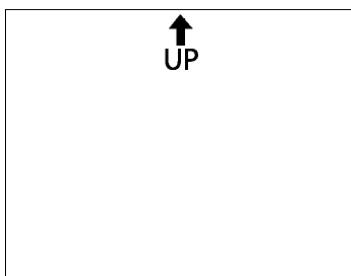

Orient the template so that the “UP” arrow is at the top of the page. Then flip the paper over so that none of the fold lines are showing.

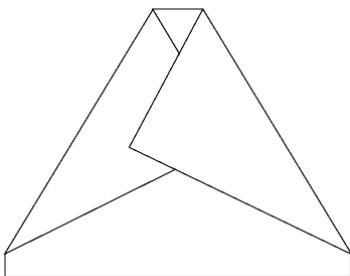

Fold the top right and top left corners in until fold lines 1 appear and crease along the dotted line.

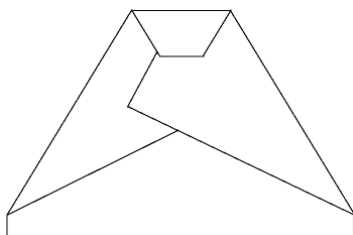

Fold the nose down toward you and crease along fold line 2.



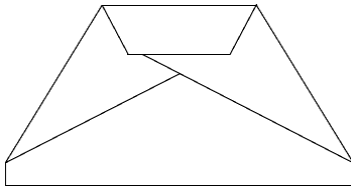

Fold the nose down toward you again and crease along fold line 3.

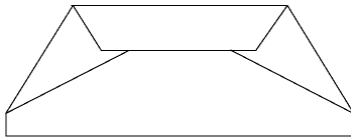

Fold the top edge down toward you again and crease along fold line 4.

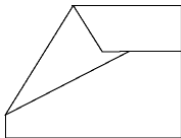

Flip the plane over and fold the right half over the left half along fold line 5.

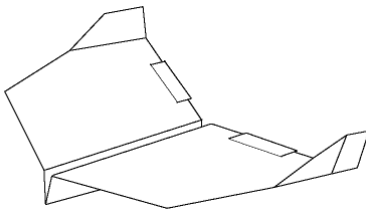

Flip the wings down along fold lines 6 and the winglets up along fold lines 7. Cut slits along the back wing edge for the elevator adjustment. Add wing dihedral by tilting the wings up slightly away from the fuselage. The wings will have a slight “V” shape when viewed from the front. You are ready to fly!

